

SGS Safety Grid System

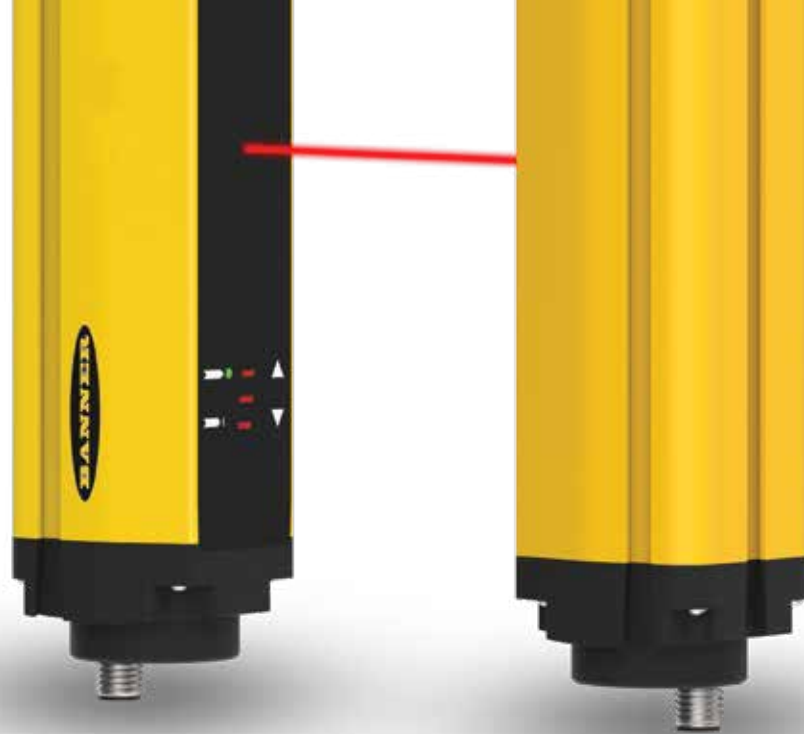

- Heavy-duty aluminium housing for tough environments
- Easy alignment and installation with on-board alignment lamp and indicators
- Protected heights of 500, 800, 900 or 1200 mm available
- Up to 60 meter range available for perimeter guarding applications
- Muting solutions available for entry/exit conveyors or palletizing cells



Introducing the SGS Safety Grid System

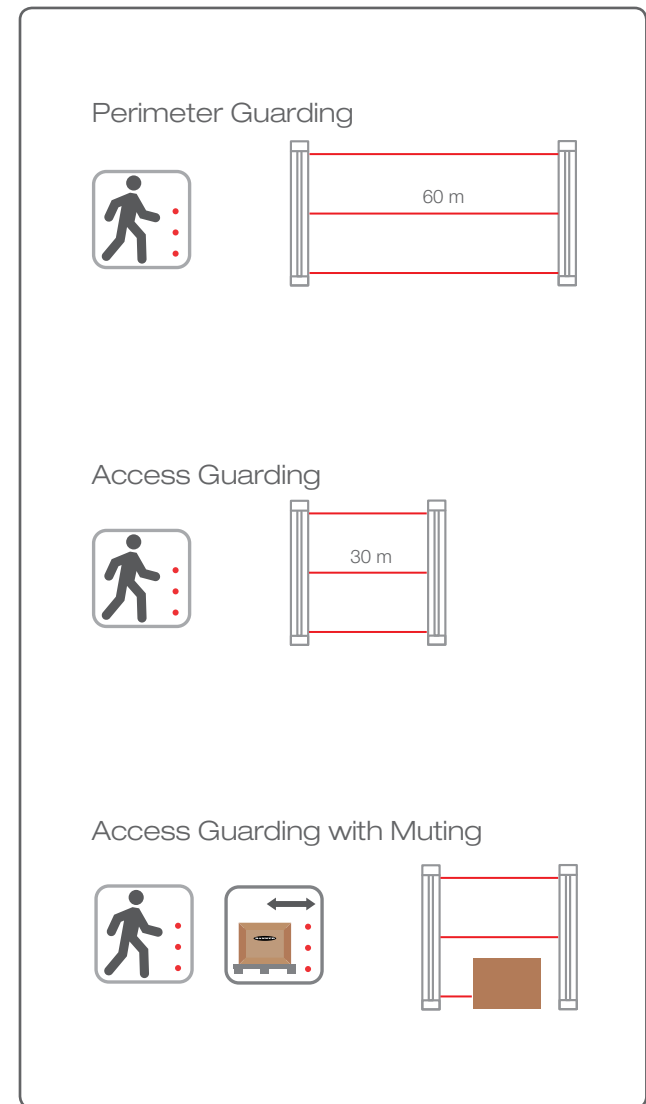
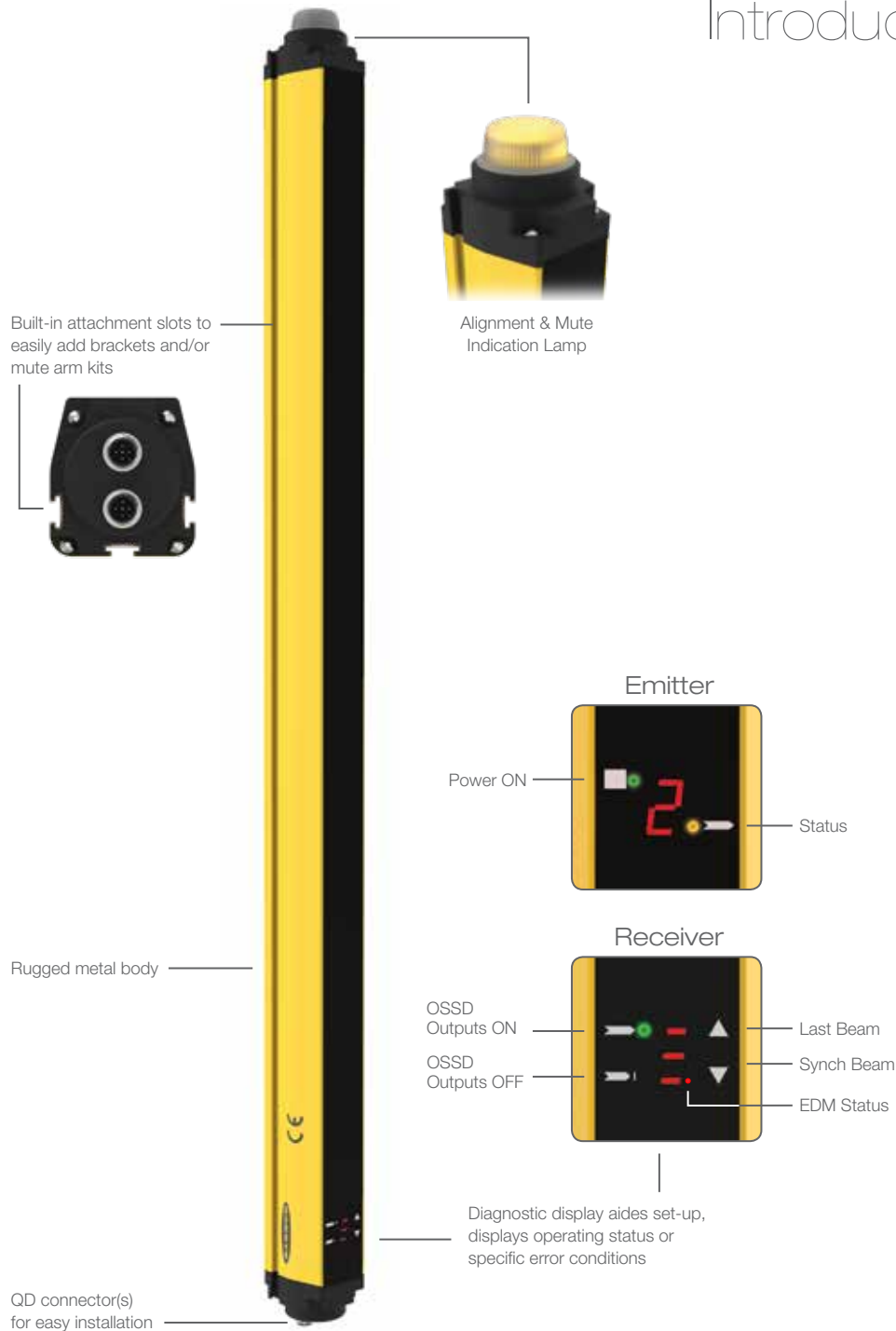

Safety Made Simple

Choose the Solution for Your Application

Emitter & Receiver
Long Range



Emitter & Receiver
Standard Range

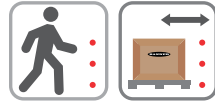

Active + Passive
Standard Range



Available Models and Capabilities

	SGSXP	SGSMP, SGSSP	SGSMA, SGSSA, SGSB	
Max Sensing Range (m)	6 to 60 m	0.5 to 30 m	0.5 to 8 m (6.5 m*)	
Type IEC 61496-1, -2	Type 4	Type 4	Type 4	
Unit Type	Emitter/Receiver	Emitter/Receiver	Active + passive	
Functions	Reset	✓	✓	
	EDM	✓	✓	
	Scan Code	✓	✓	
	Integral Muting	-	✓ (SGSMP)	✓ (SGSMA, SGSB)
	Override Input	-	✓ (SGSMP)	✓ (SGSMA, SGSB)

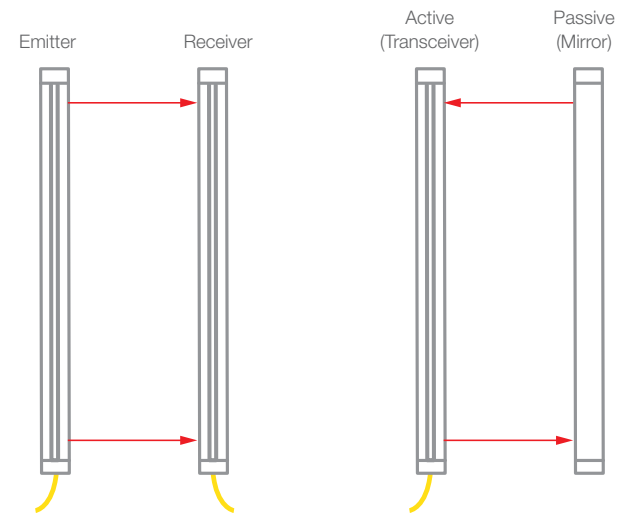

Emitter & Receiver

- When compared to higher resolution light screens, a lower cost option for body detection applications
- Available with integral muting
- Long range—up to 60 m

Active + Passive

- Active transceiver contains emitter and receiver
- Reduces overall wiring costs
- Available with integral muting
- Up to 8 m range

Available Protective Heights and Beam Spacings

2 beams

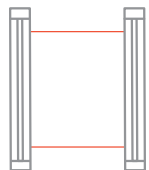

500 mm protected height
(500 mm beam spacing)

3 beams

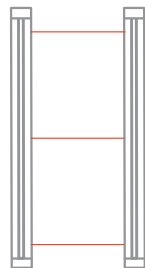

800 mm protected height
(400 mm beam spacing)

4 beams

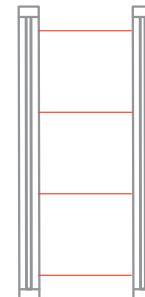

900 mm protected height
(300 mm beam spacing)

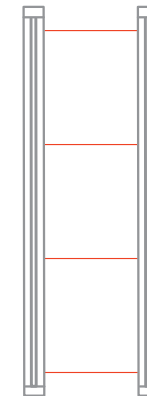

1200 mm protected height
(400 mm beam spacing)



Benefits of Muting

Integral Muting allows monitoring of redundant mute device inputs and automatically suspends (mutes) the safeguarding function of a device during the non-hazardous portion of the machine cycle.

- Maintain high safety standards while allowing for a predetermined object to break a beam
- Limit downtime by not unnecessarily shutting down a conveyor or robot cell

Applications:

- Palletizers
- Assembly and packaging machines
- Automated production equipment
- Robotic work cells
- Automated warehouses

SGS Mute Arm Kits

- Pre-assembled for plug-and-play connection to the SGS grid
- Wiring connection block or cable accessories available
- Adjusts easily for line changes

L-Configuration

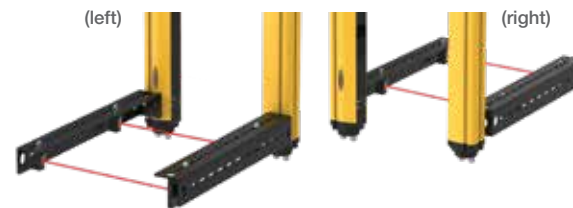

SGSA-ML-L-LPQ20

includes 2 mute arms, 2 SGSA-Q20PLPQ5 mute sensors, and 2 retroreflectors

SGSA-ML-R-LPQ20

T-Configuration

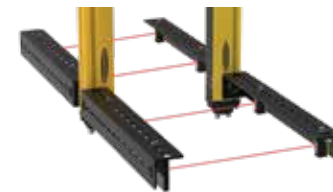

SGSA-MT-LPQ20

includes 4 mute arms, 4 SGSA-Q20PLPQ5 mute sensors, and 4 retroreflectors

X-Configuration



SGSA-MX-LPQ20

includes 4 mute arms, 2 SGSA-Q20PLPQ5 mute sensors, and 2 retroreflectors

Box or Pallet Muting

Mute Arm Kit	Enter/Exit Direction	Width & Shape	Position on Conveyor
L-Configuration	One-way (exit)	Varying	Varying
X- Configuration	Bi-Directional	Consistent	Consistent
T-Configuration	Bi-Directional	Varying	Varying

Build a Safety Solution

- Use Active + Passive for lower installed cost
- Integral muting models available for reduced wiring and cost

1. Choose one

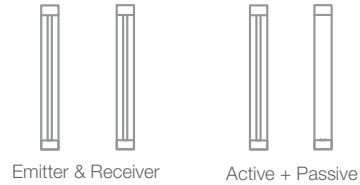

Long Range:
Emitter & Receiver Only: 6 to 60 m

Standard Range:
Active + Passive: 0.5 to 6.5 or 8 m
Emitter & Receiver: 0.5 to 30 m

2. Choose your protected height

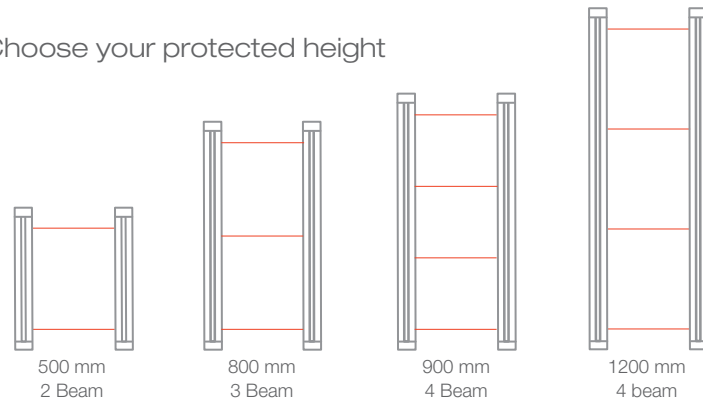

3. Choose one



Emitter & Receiver

Type	Protective Height (mm)	Range (m)	Integral Muting	Model
Emitter & Receiver	500 (2 beams)	6 to 60	No	SGSXP2-500Q88
	800 (3 beams)			SGSXP3-400Q88
	900 (4 beams)			SGSXP4-300Q88
	1200 (4 beams)			SGSXP4-400Q88
Emitter & Receiver	500 (2 beams)	0.5 to 30	No	SGSSP2-500Q88
	800 (3 beams)			SGSSP3-400Q88
	900 (4 beams)			SGSSP4-300Q88
	1200 (4 beams)			SGSSP4-400Q88
Emitter & Receiver	500 (2 beams)	0.5 to 30	Yes	SGSMP2-500Q128
	800 (3 beams)			SGSMP3-400Q128
	900 (4 beams)			SGSMP4-300Q128
	1200 (4 beams)			SGSMP4-400Q128

Active (requires Passive Mirror)

Type	Protective Height (mm)	Range (m)	Integral Muting	Model
Active Transceiver	500 (2 beams)	0.5 to 8	No	SGSSA2-500Q8
	800 (3 beams)	0.5 to 8		SGSSA3-400Q8
	900 (4 beams)	0.5 to 6.5		SGSSA4-300Q8
	1200 (4 beams)	0.5 to 8		SGSSA4-400Q8
Active Transceiver	500 (2 beams)	0.5 to 8	Yes	SGSMA2-500Q12
	800 (3 beams)	0.5 to 8		SGSMA3-400Q12
	900 (4 beams)	0.5 to 6.5		SGSMA4-300Q12
	1200 (4 beams)	0.5 to 8		SGSMA4-400Q12

Passive Mirror

Type	Protective Height (mm)	Range (m)	Model
Passive Mirror Assembly	500 (2 beams)	Pair with Active Transceivers with matching beams and protective heights	SGSB2-500
	800 (3 beams)		SGSB3-400
	900 (4 beams)		SGSB4-300
	1200 (4 beams)		SGSB4-400

Connection Options

8-Pin

8-Pin M12/ Euro-Style



QDEG-815D 4.5 m (15')	QDEG-875D 22.8 m (75')
QDEG-825D 7.6 m (25')	QDEG-8100D 30.4 m (100')
QDEG-850D 15.2 m (50')	

8-Pin Male M12 to Dual 8-Pin Female M12 Euro-Style Splitter

CSB-M1280M1280 No trunk/ no branches	
CSB-M1281M1281 0.3 m (1') trunk/2 x 0.3 m (1') branches	
CSB-M1288M1281 2.44 m (8') trunk/2 x 0.3 m (1') branches	
CSB-M12815M1281 4.57 m (15') trunk/2 x 0.3 m (1') branches	
CSB-M12825M1281 7.62 m (25') trunk/2 x 0.3 m (1') branches	

12-Pin

12-Pin M12/ Euro-Style



QDEG-1215E 4.5 m (15')	QDEG-1275E 22.8 m (75')
QDEG-1225E 7.6 m (25')	QDEG-12100E 30.4 m (100')
QDEG-1250E 15.2 m (50')	

8-Pin M12/Euro-Style Double-Ended

DEE2R-81D 0.3 m (1')	DEE2R-825D 7.6 m (25')	
DEE2R-83D 0.9 m (3')	DEE2R-830D 9.1 m (30')	
DEE2R-88D 2.5 m (8')	DEE2R-850D 15.2 m (50')	
DEE2R-812D 3.6 m (12')	DEE2R-875D 22.9 m (75')	
DEE2R-815D 4.6 m (15')	DEE2R-8100D 30.5 m (100')	

Mute Connect

Model	Description
SGSA-MCB	Connection box for X, L or T mute arm kits
SGSA-MCS-2	Connection cable for X and L mute arm kits
SGSA-MCS-4	Connection cable for T mute arm kits
SGSA-MCB-HW	Optional hardware kit for mounting mute connection box, or mute connection cable to the t-slot of SGS Receiver or Active Unit

Mirrors and Stands

SSM Series Corner Mirrors



Mirror Model	Fits SGS Models	Reflective Area (Y)	Mounting Area (L1)	Mirror Height (L2)
SSM-550	SGS..2-500..	550	661	628
SSM-825	SGS..3-400..	825	936	903
SSM-975	SGS..4-300..	975	1086	1053
SSM-1275	SGS..4-400..	1275	1386	1353

MSA Series Stands



Stand Model	Pole Height	Usable Stand Height
MSA-S66-1	1676 mm (66")	1550 mm (61")
MSA-A84-1	2134 mm (84")	2007 mm (79")
MSA-S105-1	2667 mm (105")	2667 mm (100")

Alignment Aids



Model	Description
LAT-1-SGS	Self-contained visible-beam laser tool for aligning the SGS system components. Includes laser alignment tool, retroreflective target material and mounting clip.
SGSA-LAT-1	Clip-on reflective target for use with LAT-1-SGS
SGSA-LAT-2	Replacement clip for attaching LAT and Reflector to SGS Grid
BRT-THG-2-100	2 inch retroreflective tape, 100 ft
BT-1	Beam Tracker

Interface Options

Safety Controllers



XS26-2

XS26-2d

XS26-2e

XS26-2de

Expandable safety controller supports up to eight I/O modules and programs easily using icon-based software



SC26-2

SC26-2d

SC26-2e

SC26-2de

Flexible, efficient safety controller has small footprint and programs easily using icon-based software* to match XS description

Safety Modules



UM-FA-9A

UM-FA-11A



IM-T-9A

IM-T-11A

Monitors solid-state PNP OSSD safety outputs and provides latching (manual reset) function for applications requiring a reset

Interface Modules provide isolated safety output contacts for a solid-state output (OSSD) device. It requires monitoring with the External Device Monitoring (EDM) function

Contactors



11-BG00-31-D-024

BF1801L024

Two contactors are required for higher levels of safety performance and requires monitoring by External Device Monitoring (EDM) function.





Bracket



SGSA-MBK-10-4
end-mount bracket (4 included)

EZ-LIGHTs for SGS Models without Integral Muting

Provides clear, 360° indication of the SGS receiver's output status and receiver lockouts. EZ-LIGHTs or other means of indication must draw less than 100 mA at 24 V dc.

Model	Model	Model
 M18RGX8PQ8	 K30LRGX8PQ8	 K50LRGX8PQ8
 T18RGX8PQ8	 T30RGX8PQ8	 K80LRGX8PQ8

Specifications



Emitter and Receiver



Electrical

Supply Voltage	24 V dc \pm 20% (At a minimum, use a SELV-rated power supply according to EN IEC 60950. Depending on the installation, a Class 2 low-voltage power supply and circuit as described by NFPA 70 may be required.)
Power Consumption	Emitter: 2.5 W maximum Receiver: 4 W maximum (without load)
Electrical Protection	Class III (per IEC 61140)
Outputs Signal Switching Devices (OSSDs)	2 PNP Short-circuit protection (1.4 A at 55 °C) Maximum output current: 0.5 A maximum per output On-state voltage: Power supply value less 1 V dc Off-state voltage: 0.2 V dc maximum (no load) Maximum load capacitance: 2.2 μ F at 24 V dc
Response Time	11 to 24 ms (varies by model)

Optical

Light Source	Infrared LED (950 nm wavelength)
Operating Distance (Range)	0.5 m to 60 m (depending on model)

Mechanical and Environmental

Construction	Housing: Painted aluminium (yellow RAL 1003) Caps: PBT Valox 508 (pantone 072-CVC) Front glass: PMMA
Environmental Rating	IEC IP65 (EN 60529)
Vibration and Shock	0.35 mm width, 10...55 Hz frequency, 20 sweep for each axis, 1 octave/min (EN 60068-2-6) 16 ms (10g) 1.000 shock for each axis (EN 60068-2-29)
Environmental Conditions	Operating: 0 °C to +55 °C (+32 °F to +131 °F) Storage: -25 °C to +70 °C (-13 °F to +158 °F) Temperature Class: T6 15% to 95% (non-condensing) relative
Certifications	 



Active + Passive



189697

© 2018 Banner Engineering Corp. Minneapolis, MN USA

1-888-373-6767

www.bannerengineering.com

BANNER[®]
more sensors, more solutions